

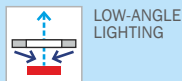

RADIAL LIGHTING

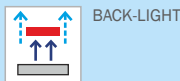

LOW-ANGLE LIGHTING



BACK-LIGHT

ALU SERIES

Ultra diffuse ringlights

Ringlights are used to illuminate objects from camera axis providing a ULTRA-DIFFUSE and uniform frontal light, ideal to obtain contrast and uniformity in order to inspect brightly or specular shining objects.

Eliminates brightness and shadows.

► Technical specifications¹

Lighting model	ALU0502A	ALU0704A	ALU1006A
Dimensions	55x55x20	75x75x22	100x100x28
Inner Ø	20	37	61
RWD (mm)	<115	<120	<190
Weight	85g	130g	260g
IP rating	IP40 ²	IP40 ²	IP40 ²
Mounting holes	(x3)M4T6	(x4)M4T6	(x4)M4T6 (x3)DIN913 M5@120°
Connection (Type C/S)	2P male chassis connector PIN 1 = +24V ±3% PIN 2 = 0V	2P male chassis connector PIN 1 = +24V ±3% PIN 2 = 0V	2P male chassis connector PIN 1 = +24V ±3% PIN 2 = 0V
Power cable (Not-included)	VCB Series	VCB Series	VCB Series
Modifiers³			
Accessories⁴			
iBlueDrive tech.	inline	inline	inline
iBlueDrive connection	3P aerial male inline connector. L= 715mm. PIN 1 = +24V ±8% PIN 2 = 0V PIN 3 = Control ⁵	3P aerial male inline connector. L= 715mm. PIN 1 = +24V ±8% PIN 2 = 0V PIN 3 = Control ⁵	3P aerial male inline connector. L= 715mm. PIN 1 = +24V ±8% PIN 2 = 0V PIN 3 = Control ⁵
iBlueDrive power cable (Not-included)	VCC Series	VCC Series	VCC Series
iBlueDrive accessories⁴			

► Instantaneous consumption⁶ (max.)

Lighting model	ALU0502A	ALU0704A	ALU1006A	*WT	
TYPE C 24VDC		2.2W	3.4W	5.5W	-470C
		2.2W	3.4W	5.5W	-525C
		2.5W	3.8W	6.4W	-630C
		2.5W	3.8W	6.4W	-850C
		2.2W	3.4W	5.5W	-W00C
TYPE P	No "Type P" standard LED lighting systems in this series				
TYPE S D _{max} = 1/2 ₀ Ton max= 2ms		350mA/8.4W	530mA/13W	880mA/21W	-470S
		350mA/8.4W	530mA/13W	880mA/21W	-525S
		350mA/8.4W	530mA/13W	880mA/21W	-630S
		835mA/20W	1255mA/30W	2090mA/50W	-850S
		350mA/8.4W	530mA/13W	880mA/21W	-W00S
	N/A	600mA/14W channel	1000mA/24W channel	-RGBS	
TYPE i⁷ 		2.2W[10W/1.7W]	3.1W[15W/2.4W]	4.8W[24W/3.6W]	-470i
		3.4W[10W/2.4W]	4.8W[15W/3.4W]	7.7W[24W/5.3W]	-525i
		3.4W[10W/2.4W]	4.8W[15W/3.4W]	7.7W[24W/5.3W]	-630i
		6.2W[20W/3.4W]	9.1W[29W/4.8W]	15W[48W/7.7W]	-850i
		3.4W[10W/2.4W]	4.8W[15W/3.4W]	7.7W[24W/5.3W]	-W00i

N/A= Not available

(1) Environmental specifications and iconography legend in additional annex Z1.4 and Z2 respectively.

(2) IP43 if the system is positioned so that the light falls vertically.

(3) Prior to manufacturing optional modifications in standard lighting systems. Please, consult the code before ordering (additional annex Z2.1).

(4) Accessories are not-included. More information in accessories section.

(5) iBlueDrive control input wiring specifications in additional annex Z1.2.

(6) Bear in mind that consumption table is only to be used as a guide. To refer to real values, please, consult product label when purchasing.

(7) Values of maximum instantaneous consumption of "Type i" lighting systems in Powered mode [Strobe mode / Continuous mode]



ALU SERIES

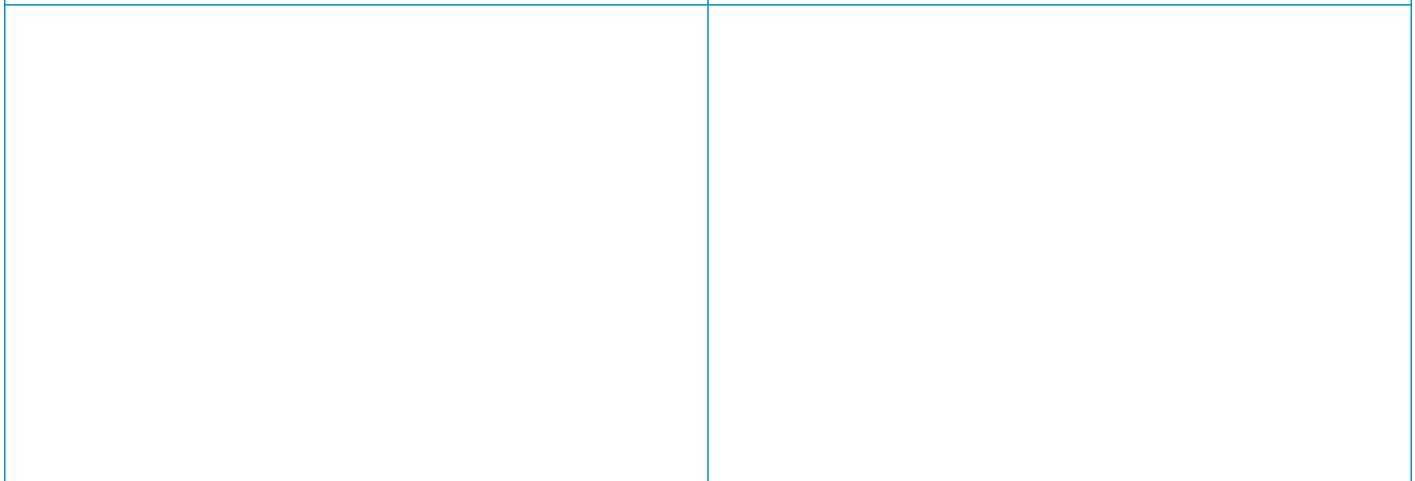
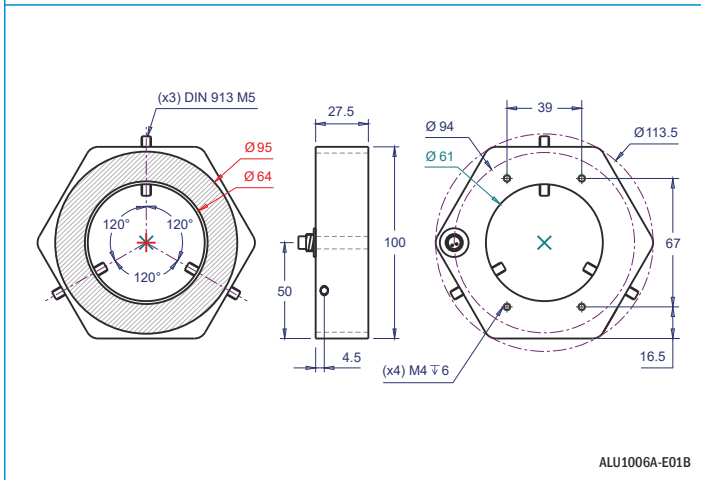
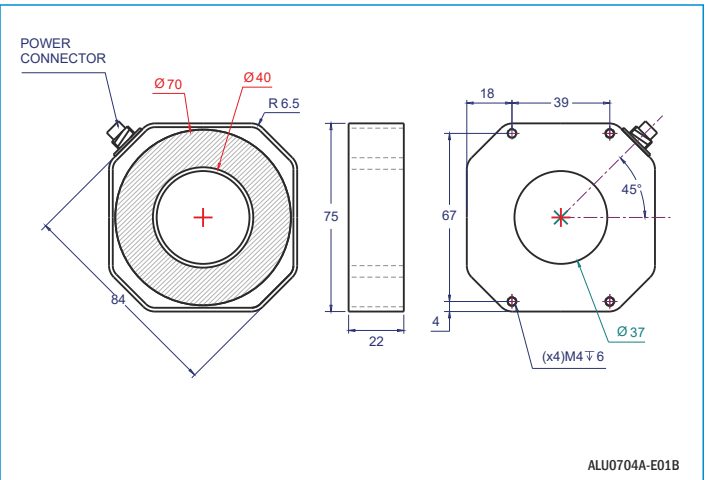
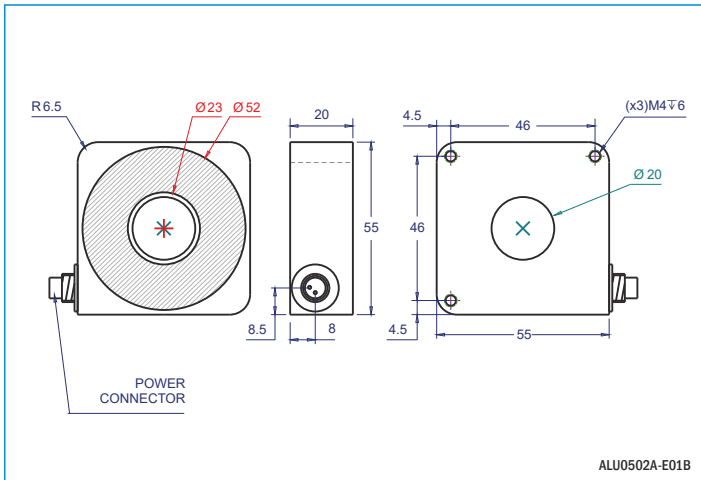

All units in millimeters, if not indicated.

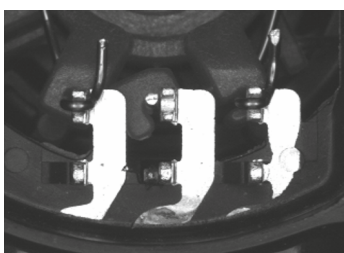

Example of ALU captured image

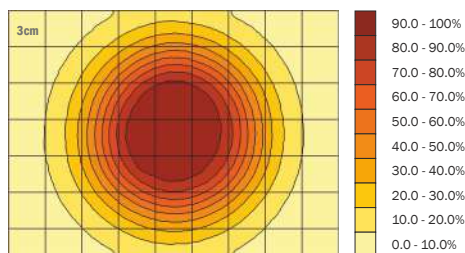

Brightness distribution of ALU1006A-630C@50mm

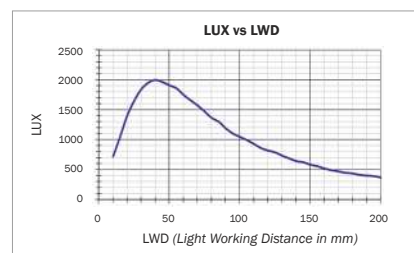



► Z2.1 - iBlueDrive control input wiring

All iBlueDrive products come together with a quick-start guide for connection and working conditions. Refer to iBlueDrive Manual for extended information.

NPN wiring for strobe or ON/OFF mode

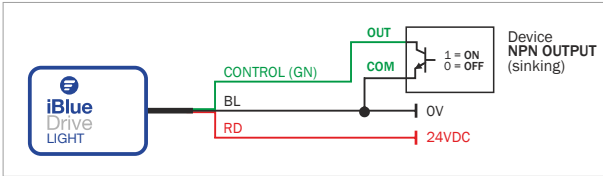

PNP wiring for strobe or ON/OFF mode

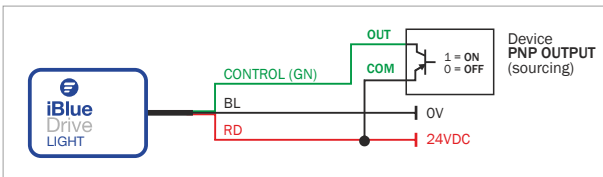

TTL wiring for strobe or ON/OFF mode

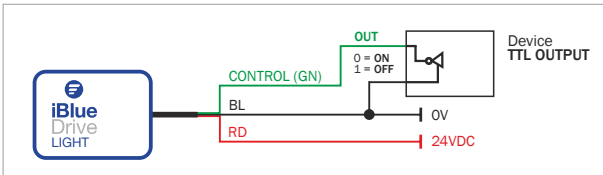

Wiring for continuous mode

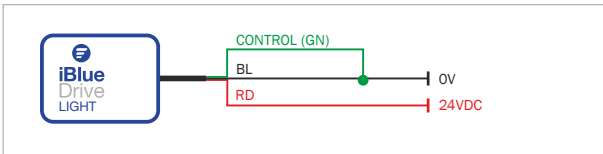

► Z2.2 - iBlueDrive inline

iBlueDrive inline is the driver for iBlueDrive technology integrated as a box of 65x33mm to the cable that goes from the lighting system to the connector. It is used when iBlueDrive driver can not be integrated on chassis. See *diagram*:

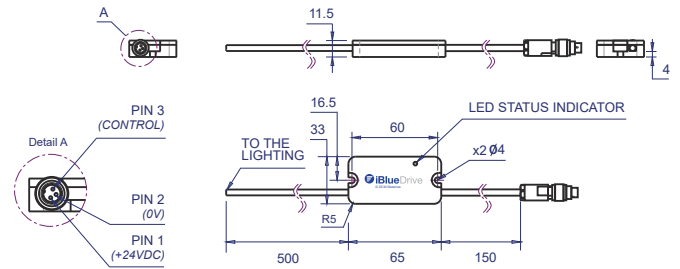



WARNING! In continuous and powered mode, clamp driver to a metal surface for heat dissipation. In Strobe mode is not required, but recommended.

► Z2.3 - iBlueDrive Accessories legend

















icon	Description	Serie/Product
	Accessorie to configure iBlueDrive devices: iBlueDrive Box, iBlueDrive USB	VTA0005A, VTA0006A, VTA0007A
	iBlueDrive optocoupler	VTA0020A
	iBlueDrive potentiometer	VTA0030B















► Z3.1 - Environmental Specifications

Max. Operating Humidity	85% non-condensing
Operating Temperature	0 - 40°C
Storage Temperature	0 - 60°C
Housing material	Anodized aluminium
Standards	  





► Z3.2 - Modifiers legend

icon	Description	Code
	Narrow angle of emission	/AN
	Medium angle of emission (default)	/AM
	Wide angle of emission	/AW
	Oval angle of emission = 23-24° (x) 17-18° (y)	/AO
	Diffuse emission	/AD
	Polarizer filter	/FPL
	Diffuser filter	/FDR
	Backlight hole of 42mm	/H
	Backlight hole of 65mm	/H1
	Dome hole of 46mm	/CC1
	Dome hole of 40mm	/CC2
	IP Rating = IPxx = Ip65 / IP67	/65 / 67
	PNP input model	/P
	50mm focal Length	/F1
	150mm focal Length	/F2
	Infinite focal Length	/F3
	Lighting by sectors = 2 or 4 sectors	/2S / 4S

► Z3.3 - Accessories legend

icon	Description	Serie
	Power cable/s	VCB, VCC, VCD Series
	Other cable/s	VCU, VCL
	Strobe and RGB controller/s	VST, VSC Series
	Polarizer filter	VPF, VPC
	Diffuser filter	VDF
	Collimater filter on x axis	VCFx
	Collimater filter on y axis	VCFy
	Collimater filter on xy axis	VCFxy
	Darkfield converter	VRF
	Protector filter	VPT
	Heat dissipator	VHD
	Fixing bracket	VBA, VBB, VBC Series







► Z3.4 - Technical drawings legend

icon	Description
	Optical axis
	Viewing window dimensions
	Lighting elements
	Light emission center
	Lighting surface dimensions



► Z3.5 - Colours & Wavelegths legend

icon	Wavelength	Colour	Code
	365nm	UV-	-365
	400nm	UV	-400
	470nm	BLUE	-470
	525nm	GREEN	-525
	630nm	RED	-630
	850nm/880nm	IR	-850/-880
		WHITE	-W00
		RGB	-RGB

► Z3.6 - Types of lighting legend

icon	Description
	Radial lighting
	'Darkfield' lighting effect. Low angle illumination
	Backlight illumination
	'Cloudy day' lighting effect
	'Bright field' lighting effect
	Projector lighting
	Axial lighting

► Z3.7 - Types of light legend

icon	Description
	Direct light
	Diffuse light
	Ultra-diffuse light